

+General lifts



**General
Elevadores.**





About us

The company General Elevadores was founded in the late 1980s, when Fermín Encuentra Peralta, after many years of experience at a number of lift companies, decided to create his own.

What started out as a family business has now become a leading name in the multi-brand lift maintenance sector, with over 200 employees.

We also install lifts of our own brand and lift and accessibility equipment, without ever losing sight of the quality of the processes, in addition to an excellent customer service.

Our experience speaks for itself.

We have been active in the sector for more than 30 years, installing and conducting maintenance on accessibility equipment, lifts and other lifting devices.

A Spanish company with international expansion.

General Elevadores has offices all over Spain and countries in Europe and America.

We are the maintenance company most highly valued by its clients.

Due to our hands-on approach, involvement in each case and our personalised customer service.

We are experts in multi-brand lift maintenance.

We keep a large stock of original spare parts.

We also manufacture.

We have our own plant for the preparation of all the electronic equipment for our lifts.

We provide accessibility solutions.

We install and maintain accessibility equipment such as ramps and platforms, including our Domovil home lift.

Long call-out hours.

Our breakdown call-out hours are among the longest in the sector.

Local reinvestment.

We invest in local products, which is why our main suppliers are local.

What we provide

- + Installation of lifts and other accessibility solutions.
- + Personalised guidance.
- + R&D&I department.
- + Multi-brand maintenance service.
- + Repair and replacement with original spare parts.

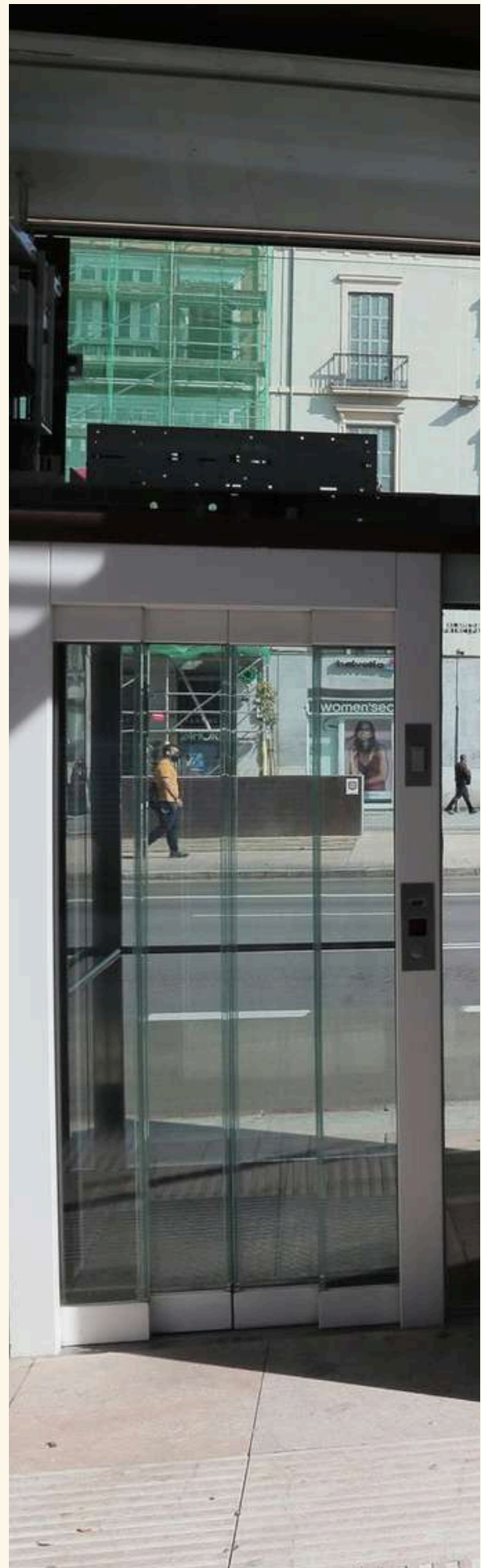



What do you need?

+ Lift Installation

We will submit the proposal best suited to the needs of communities of owners and individuals in single-family homes wishing to install a lift. We at General Elevadores analyse each project on an individual basis in order to provide you with the solution best suited to your needs, for both public and private buildings, communities of owners and single-family homes.

Get to know all the types of lift we install.

Eulift

A manually operated, gearless electric lift of a standard size and high-load capacity, mainly designed for newly built standard shafts.

Eulift-R

High quality electric elevator with direct action machine without reducer, with special dimensions from 250 kg to 630 kg for renovations with singular openings in constructions where maximum use of the opening is required. It adapts perfectly to buildings where there is no elevator or where the existing elevator needs to be replaced with a more accessible and efficient one.

Familift

A hydraulic lift with a machine room or compact cabinet (with no machine room) for different loads. Ideal for special shafts with few stops up to 1600 kg, featuring an electronic valve group for a smooth stop and start, very quiet and comfortable.

Domovil

A lift from our accessibility catalogue, which we ourselves manufacture. This is a single-family residence hydraulic lift with a reduced speed of up to 0.15 m/s, specifically designed for facilities in need of an accessible piece of equipment with a few stops, combining the advantages of a Familift (smooth, quiet and comfortable) with the low consumption of a Eulift.

Headway

A manually operated, gearless electric lift for high speeds and large load capacities. Equipment imported from our plant in Tianjin (China).

+ Eulift Model

Basic features

Type.	Gearless Electric.
Standard.	EN 81 20/50.
Speed.	1.00 m/s.
Stops.	Up to 42 m. Up to 15 stops.
Pit.	1200 mm.
Headroom.	3700 mm.
MR/MRL	MRL.
Automatic rescue.	Included - With door opening system.
Electric.	Selective - 400V 3ph 50/60 Hz

Variable features

	Eulift-450	Eulift-630	Eulift-800
Load.	450 kg.	630 kg.	800 kg.
Shaft (HWxHD).	1600 x 1500 mm.	1700 x 1650 mm.	1950 x 1650 mm.
Cabin (CWxCD).	1000 x 1250 mm.	1100 x 1400 mm.	1300 x 1400 mm.
Step width (OP).	800 mm.	800 mm.	900 mm.
Power.	2,5 KW.	3,3 KW.	4,5 KW.

Details and customisation

Cabin Model.	Instam I-01/ Hairline St. St.
Floor.	Non-slip rubber.
Handrail.	Optional.
Mirror.	Optional.
Profiles and outlets.	Hairline St. St.
Lighting.	LED tubes
Photoelectric barrier.	Included.
Landing door type.	T2H Epoxi 81.20
Cabin door type.	T2H Stainless steel 81.20
Telephone system.	Two-way intercom - Optional.
Cabin display.	Included.
Floor display.	Optional.
Cabin button panel.	Satin stainless steel plate.
Landing button panel.	Stainless steel with call and logo.

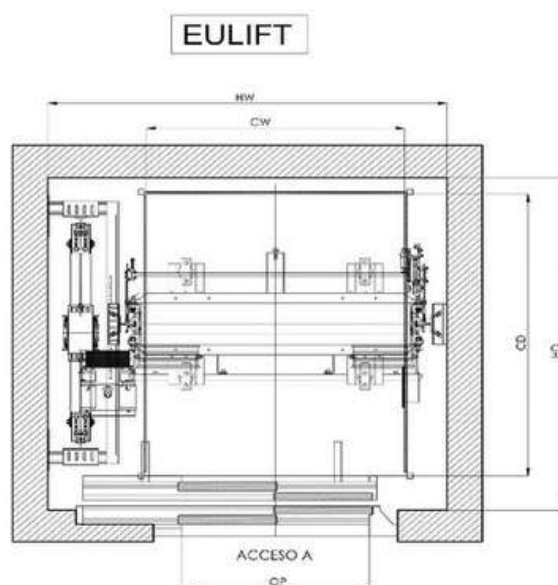

+ Eulift - R Model

Basic features

Type.	Gearless Electric.
Standard.	EN 81 20/50.
Speed.	1.00 m/s.
Stops.	Up to 42 m. Up to 15 stops.
Pit.	1200 mm.
Headroom.	3700 mm.
MR/MRL	MRL.
Automatic rescue.	Included - With door opening system.
Electric.	Selective - 400V 3ph 50/60 Hz

Variable features

	Eulift-R-320	Eulift-R-375	Eulift-R-450
Load.	320 kg.	375 kg.	450 kg.
Shaft (HWxHD).	1350 x 1250 mm.	1450 x 1350 mm.	1450 x 1500 mm.
Cabin (CWxCD).	900 x 1000 mm.	1000 x 1100 mm.	1000 x 1250 mm.
Step width (OP).	700 mm.	700 mm.	800 mm.
Power.	3,3 KW.	4,5 KW.	5,8 KW.

Details and customisation

Cabin Model.	Instam I-01/ Hairline St. St.
Floor.	Non-slip rubber.
Handrail.	Optional.
Mirror.	Optional.
Profiles and outlets.	Hairline St. St.
Lighting.	LED tubes
Photoelectric barrier.	Included.
Landing door type.	T2H Epoxi 81.20
Cabin door type.	T2H Stainless steel 81.20
Telephone system.	Two-way intercom - Optional.
Cabin display.	Included.
Floor display.	Optional.
Cabin button panel.	Satin stainless steel plate.
Landing button panel.	Stainless steel with call and logo.

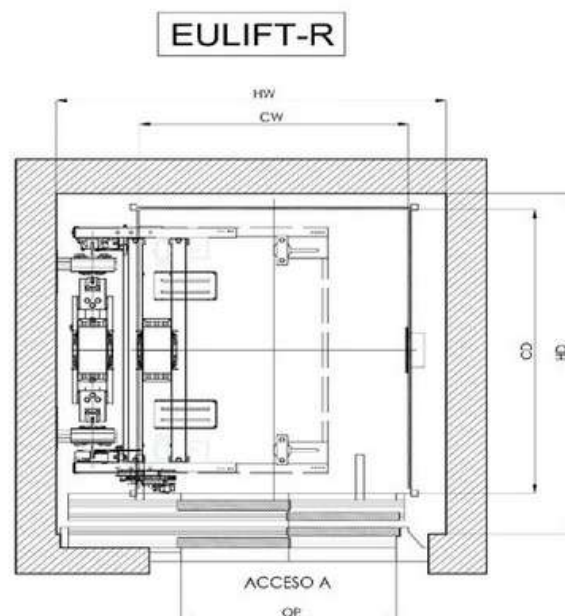

+ Familift Model

Basic features

Type.	Hydraulic.
Standard.	EN 81 20/50.
Speed.	0.63 m/s.
Stops.	Up to 15 m. Up to 6 stops.
Pit.	1200 mm.
Headroom.	3600 mm.
MR/MRL	MR.
Automatic rescue.	Included - Without door opening system.
Electric	Selective - 400V 3ph 50/60 Hz

Variable features

Familift - 320 Familift - 450 Familift - 630 Familift - 800

Load.	320 kg.	450 kg.	630 kg.	800 kg.
Pit.	1200 mm.	1200 mm.	1200 mm.	1200 mm.
Shaft (HWxHD).	1350 x 1250 mm.	1400 x 1500 mm.	1600 x 1650 mm.	1850 x 1650 mm.
Cabin (CWxCD).	900 x 1000 mm.	1000 x 1250 mm.	1100 x 1400 mm.	1300 x 1400 mm.
Step width (OP).	700 mm.	800 mm.	800 mm.	900 mm.
Power.	7,5 KW.	9,5 KW.	15 KW.	18.5 KW.

Details and customisation

Cabin Model.	Instam I-01/ Hairline St. St.
Floor.	Non-slip rubber.
Handrail.	Optional.
Mirror.	Optional.
Profiles and outlets.	Hairline St. St.
Lighting.	LED tubes
Photoelectric barrier.	Included.
Landing door type.	T2H Epoxi 81.20
Cabin door type.	T2H Stainless steel 81.20
Telephone system.	Two-way intercom - Optional.
Cabin display.	Included.
Floor display.	Optional.
Cabin button panel.	Satin stainless steel plate.
Landing button panel.	Stainless steel with call and logo.

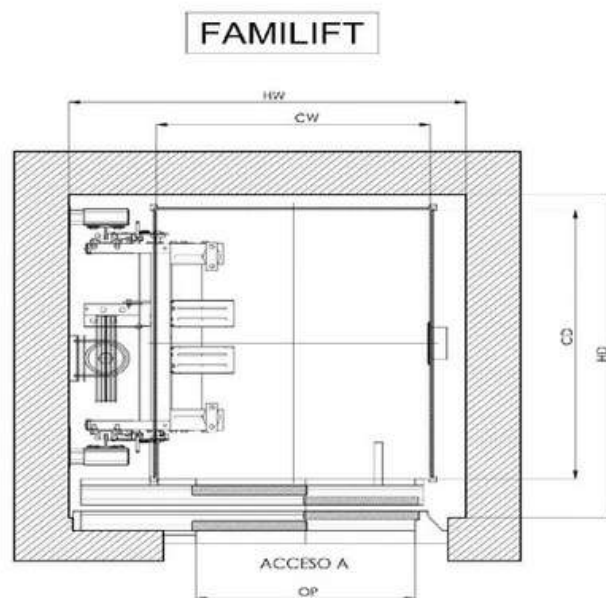

One cabin for each
environment.



+ Chance CH-01 Cabin



Finishes included

Decorated cabin with painted sheet metal, non-slip rubber flooring, with options for other materials (granite, marble, artificial stone, etc.). Features a folding ceiling in black or white painted sheet metal with polycarbonate in various finishes, LED timed lighting, and the possibility of adding a mirror and handrails. Profiles and jambs are made of metallic gray painted sheet metal.

* Informative model.
Check availability.

+ Panels



Blanco
RAL 9016



Beige
RAL 1019



Violeta pastel
RAL 4009



Gris hormigón
RAL 7023



Negro
RAL 9005



Marfil claro
RAL 1015



Gris claro perla
RAL 9022



Gris metaliza-
do RAL 9006

+ Non-slip rubber



Gris



Beige



Negra



Azul acero

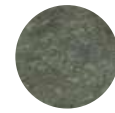

Gris
cemento



Arena



Roble

+ Roofs



Arte



Mondrian

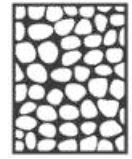

Mineral

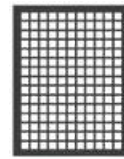

Mosaic



Infinite



Fraction



Marco



Spots LED



Panel LED



Barras LED

+ Extras:



Handrail



Floor
Display

+ Sansa S-01 Cabin



Finishes included

Decorated cabin with skinplate laminated sheet metal, non-slip rubber flooring, with options for other materials (granite, marble, artificial stone, etc.). Features a folding ceiling in black or white painted sheet metal with polycarbonate in various finishes, LED timed lighting. Silver mirror. False handrail below the mirror. Profiles and jambs made of metallic gray painted sheet metal.

* Informative model.
Check availability.

+ Skinplate

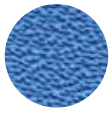

Azul



Crema



Gris



Negro



Blanco

+ Non-slip rubber



Gris



Beige



Negra



Azul acero



Gris cemento



Arena



Roble

+ Extras:



Handrail



Floor Display

+ Roofs



Arte



Mondrian

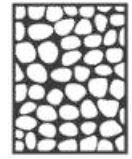

Mineral

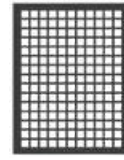

Mosaic



Infinite



Fraction



Marco



Spots LED



Panel LED



Barras LED

+ Lane L-04 Cabin



Finishes included

Decorated cabin with galvanized sheet metal covered with smooth laminated panels, non-slip rubber flooring, with options for other materials (granite, marble, artificial stone, etc.). Features a folding ceiling in black or white painted sheet metal with polycarbonate in various finishes, LED timed lighting. Silver mirror. False handrail below the mirror. Profiles and jambs made of satin stainless steel.

* Informative model.
Check availability.

+ Laminate



Blanco Francia



Arena Petrea



Grafito



Elemental Concrete



Elemental Graphite



Elemental Corten



Azul China



White Ash



Roble



Natural Teak

+ Non-slip rubber



Gris



Beige



Negra

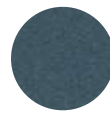

Azul acero



Gris cemento



Arena



Roble

+ Extras:



Handrail



Floor Display

+ Roofs



Arte



Mondrian

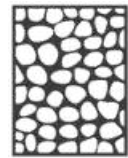

Mineral

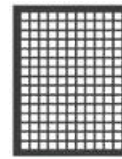

Mosaic



Infinite



Fraction



Marco



Spots LED



Panel LED



Barras LED

+ Idea I-01D Cabin



Finishes included

Cabin decorated in satin stainless steel sheet, non-slip rubber floors, with the option of other materials (granite, marble, artificial stone, etc...), folding roof made of black or white painted sheet metal with polycarbonate in various finishes, lighting timed led. Silver mirror. False handrail under mirror. Satin stainless steel profiles and mouthpieces.

* Informative model.
Check availability.

+ Stainless Steel



Satinado

+ Non-slip rubber



Gris



Beige



Negra



Azul acero



Gris
cemento



Arena



Roble

+ Extras:



Handrail



Floor
Display

+ Roofs



Arte



Mondrian

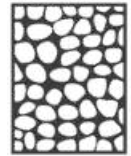

Mineral

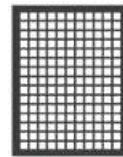

Mosaic



Infinite



Fraction



Marco



Spots LED



Panel LED



Barras LED

+ Instam I-01 Cabin



Finishes included

Cabin decorated in galvanized sheet metal lined with satin stainless steel with satin stainless steel interlinings, non-slip rubber floors, with the option of other materials (granite, marble, artificial stone, etc.), folding roof made of black or painted sheet metal. White with polycarbonate of various finishes, timed LED lighting. Silver mirror. False handrail under mirror. Satin stainless steel profiles and mouthpieces.

* Informative model.
Check availability.

+ Stainless Steel



Satinado

+ Non-slip rubber



Gris



Beige



Negra

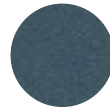

Azul acero



Gris
cemento



Arena



Roble

+ Extras:



Handrail



Floor
Display

+ Roofs



Arte



Mondrian

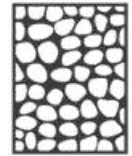

Mineral

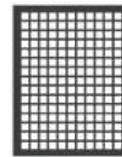

Mosaic



Infinite



Fraction



Marco



Spots LED



Panel LED



Barras LED

+ Lintel L-03 Cabin

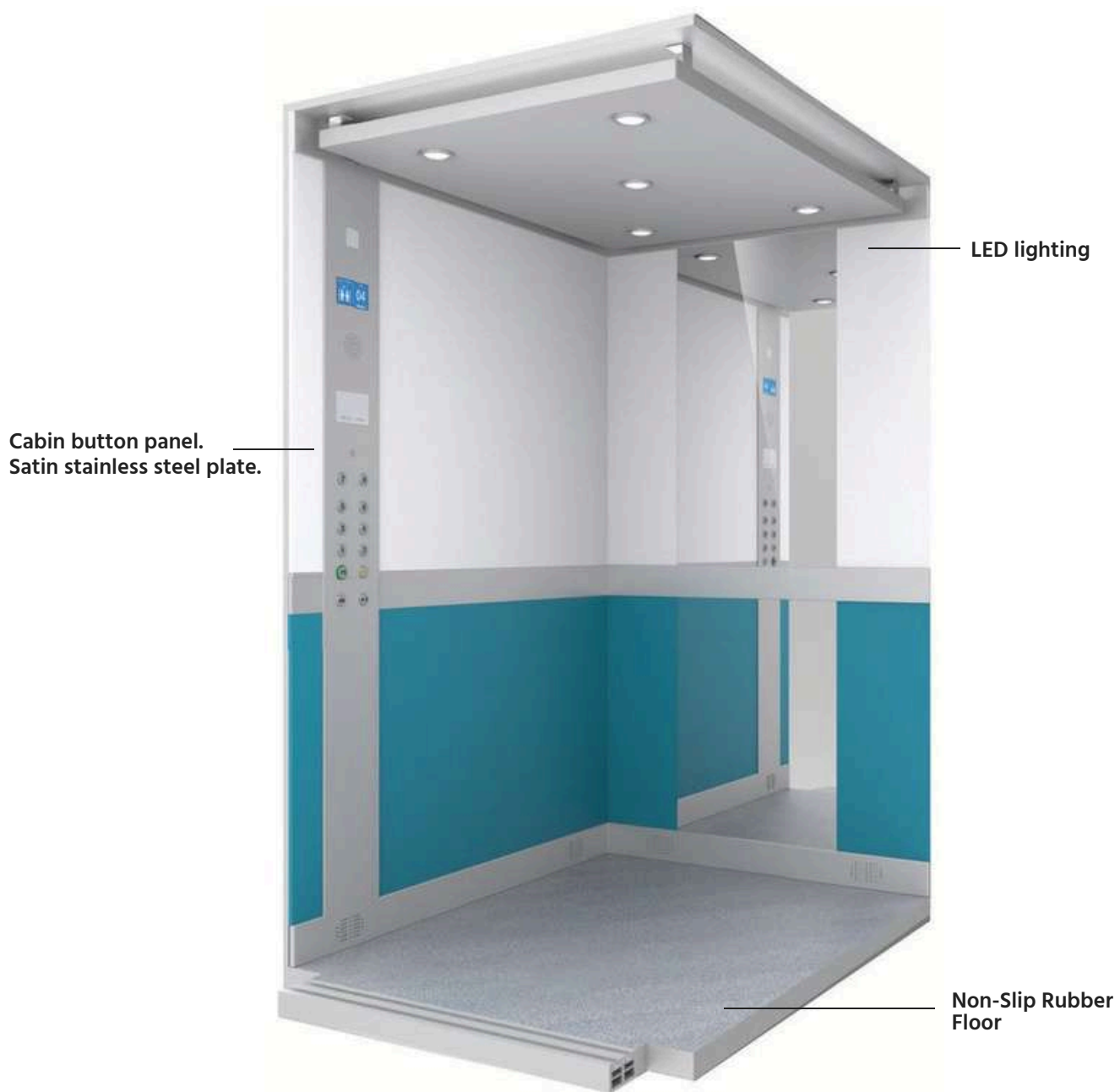

Finishes included

Cabin decorated in galvanized sheet metal covered with laminate, non-slip rubber floors, with the option of other materials (granite, marble, artificial stone, etc...), folding roof made of black or white painted sheet metal with polycarbonate in various finishes, timed LED lighting . Silver mirror. False handrail under mirror. Satin stainless steel profiles and mouthpieces.

* Informative model.
Check availability.

+ Laminates

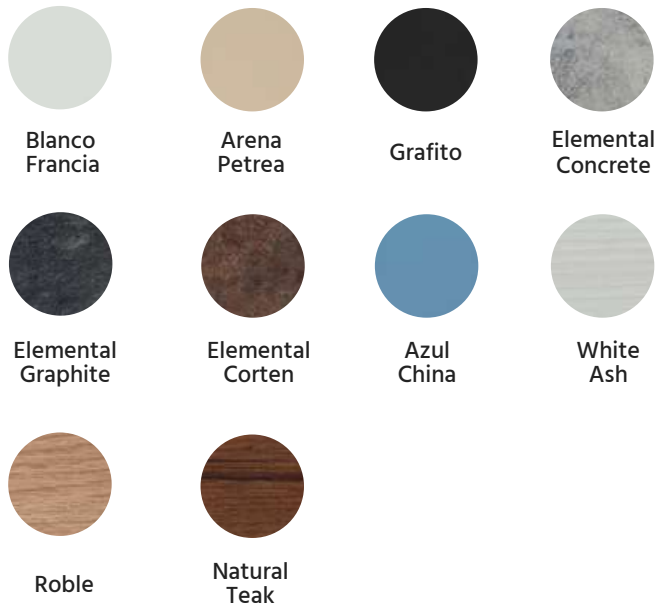

+ Non-slip rubber



+ Extras:

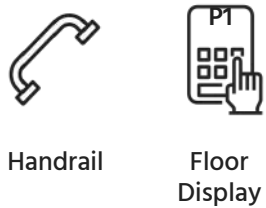

+ Roofs

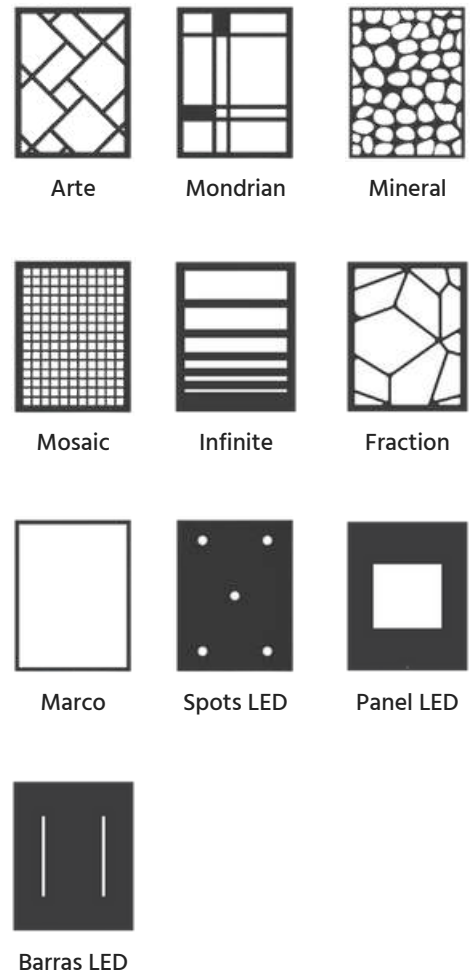

+ Quartz Q-01 Cabin

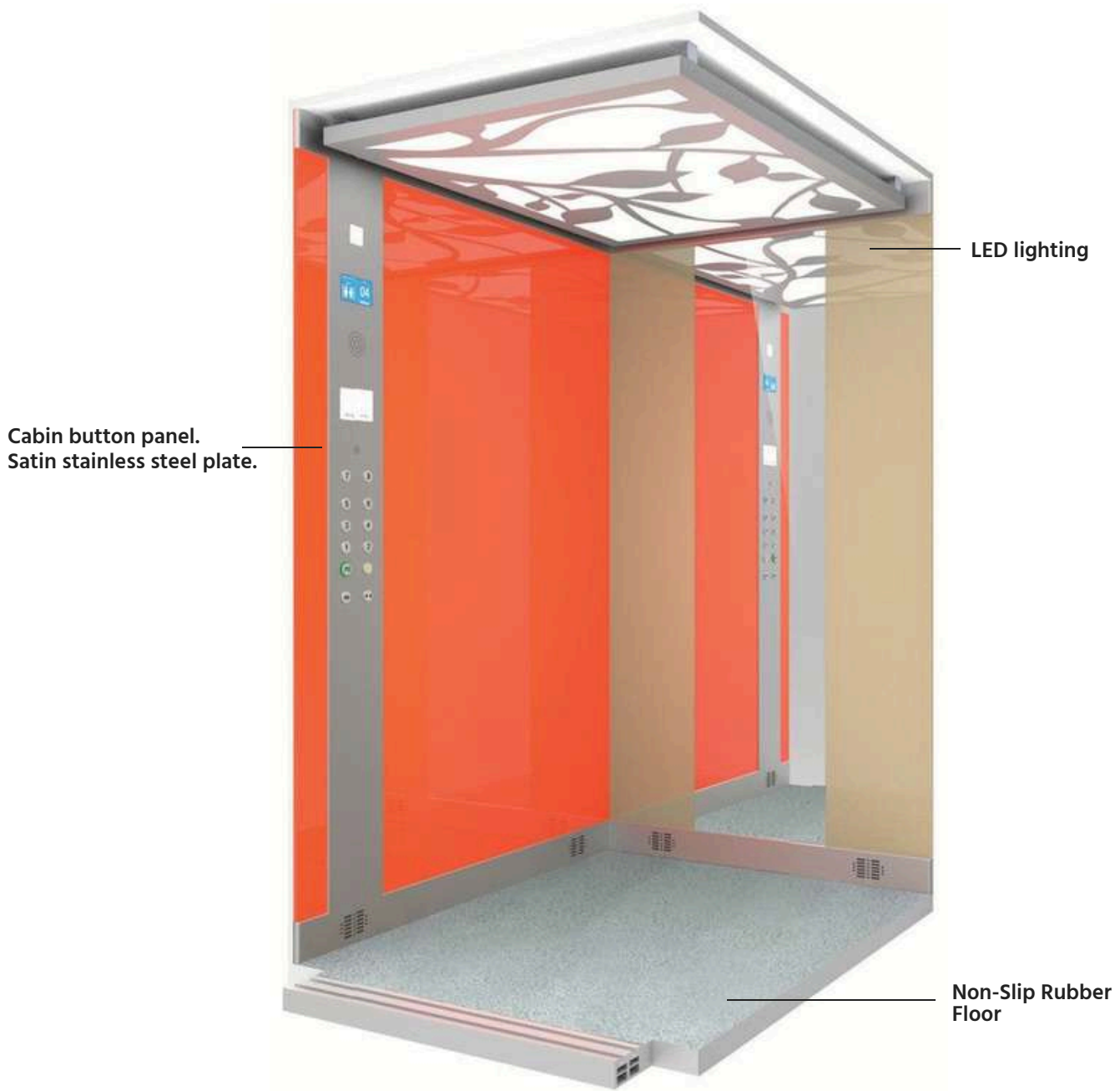

Finishes included

Non-slip rubber floors, with the option of other materials (granite, marble, artificial stone, etc...), folding roof made of black or white painted sheet metal with polycarbonate in various finishes, timed LED lighting. Silver mirror. False handrail under mirror. Satin stainless steel profiles and mouthpieces.

* Informative model.
Check availability.

+ Lacquered glass



Verde
RAL 8615



Gris Metal
RAL 9006



Marrón Claro
RAL 1236



Verde Pistacho

+ Non-slip rubber



Gris



Beige



Negra



Azul acero

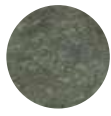

Gris
cemento



Arena



Roble

+ Extras:



Handrail



Floor
Display

+ Roofs



Arte



Mondrian

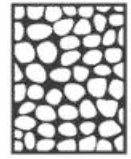

Mineral

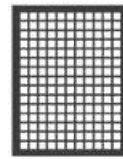

Mosaic



Infinite



Fraction



Marco



Spots LED



Panel LED



Barras LED

+ Panoramic Cabin



Glass cloths

All previous models can have glass panels and can be converted into a panoramic cabin

* Informative model.
Check availability.



+ LC702 Cabin

Headway cabin



* Informative model.
Check availability.

+ Stainless Steel



Satinado

+ Floors



+ Roofs



+ LC703 Cabin

Headway cabin



* Informative model.
Check availability.

+ Stainless Steel



Satinado

+ Floors



+ Roofs



+ LC704 Cabin

Headway cabin



* Informative model.
Check availability.

+ Stainless Steel



Satinado

+ Floors

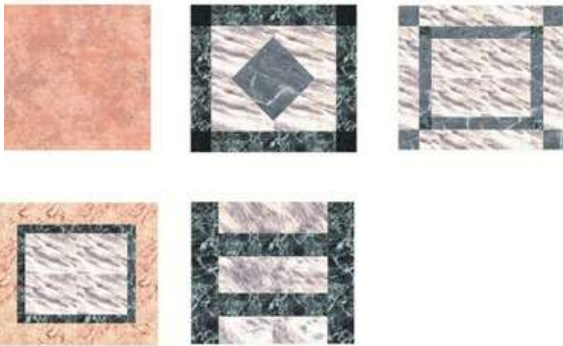

+ Roofs



+ Push-button panels



+ Control panel

With a frequency variator and programmable operation.
Provides excellent travel comfort with a smooth, safe ride with no jerks or violent stops. Silent and energy efficient.

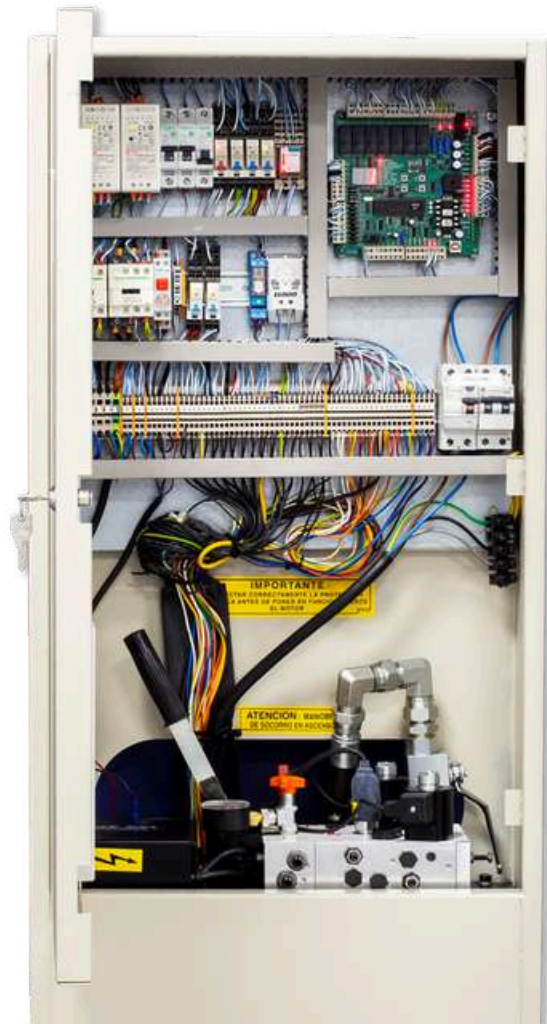



+ What if my building has no lift shaft?

Don't worry, we have the solution to that as well. We will install one on the outside of the building, on the facade or slightly away from it and connected with a walkway. We will design, manufacture and install the most suitable enclosure in accordance with your needs. We execute brick, metal plate and glass enclosures and self-supporting structures.

We analyse your lift installation project and submit a commitment-free estimate. If you accept it, we then conduct the administrative and project management procedures for the execution of the facility.



Other lift products

We also have products geared to other areas and needs, such as stretcher lifts for hospitals and residences; mini-loaders and forklifts for both individuals and restaurants, offices, hotels and hospitals; lifts and elevators for your car, etc.

Check out

Maintenance

+ Maintenance modes

We are lift maintenance specialists. We inspect your lift and other lifting devices to ensure the least possible number of incidents and breakdowns through effective preventive maintenance in accordance with European regulations.

In addition to preventive maintenance, we conduct corrective maintenance to deal with any breakdowns, providing you with security and peace of mind with regard to the use of your lift equipment.

+ 24-hour service

We will take your breakdown calls to the company from Monday to Sunday, 9 a.m. to 2 p.m. and 4 p.m. to 9 p.m., in addition to our 24-hour rescue and emergency service (365 days a year).

Moreover, you will not be charged extra for the visits paid to provide this service?

+ 72-hour service

The phone installed in your lift will enable you to contact us immediately. We check your cabin phone is in good working order every 72 hours from our headquarters.

Modernisation

Is your lift obsolete?

Do you need to modernise the cabin or any of its components?



There are many reasons for modernising your lift: to improve your comfort, to make it safer, to save energy, or simply to give it a more contemporary design. We also redesign your entrance hall so that the lift door goes down to street level.

We have a wide range of designs and finishes for cabins, doors, accessories and for the modernisation of your lift, in addition to a large stock of original spare parts.

Components

We at General Elevators have the top-quality components your lift needs, together with the continuous work of the members of our R&D&I department striving to ensure the results meet your expectations.



Accessibility

We are committed to accessibility and as such we have designed push-button panels geared to functional diversity with large horizontal buttons placed at a suitable height, with a braille system, voice synthesizer and a high-contrast display.

Our automatic lift doors are designed in accordance with the premises in which the lift is installed, with perfectly aesthetic integration and built to withstand the large volume of traffic at facilities such as shopping centres, proving maximum operational guarantees.



Why choose **General Elevadores**?

Our headquarters are located at Parque Tecnológico de Andalucía, in Málaga.

We boast:

7,000 m2 of facilities.

200 employees in our national network.

Over 250 employees around the world.

Specialised infrastructure and resources.

Global communication systems and networks.

Our own methodology and high standards of quality.

We are here to
help you





G.

Get in touch with us and tell us
what you need.

(+34) 952 020 055

info@generalelevadores.com

C/ Severo Ochoa 54. 29590 Málaga

www.generalelevadores.com



Find out where all our offices are on our website.